

Chest Freezer

Installation & User Instructions – Please keep for future reference

247/2258

BUSH
Real Life Technology

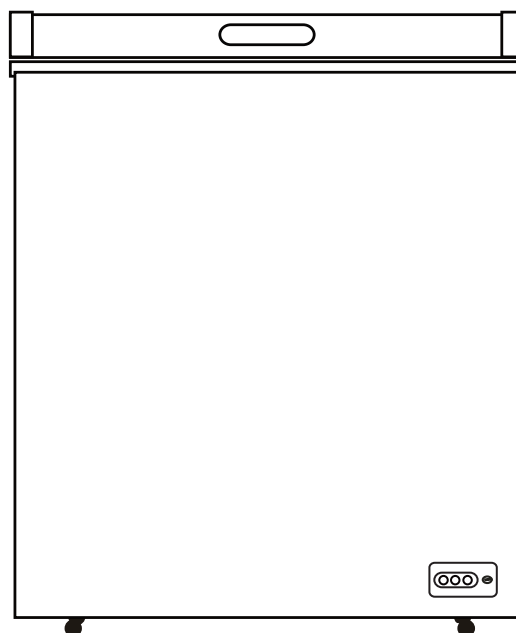

Important – Please read these instructions fully before installing or using

These instructions contain important information which will help you get the best from your appliance and ensure safe and correct installation, use and maintenance.

If you need help or have damaged or missing parts, call the Customer Helpline: 0345 600 4632

Contents

Safety Information	2-4
Parts	5
Installation	6-7
Transportation	6
Installation	6
Electrical Connection	7
User Instructions	8-9
Before first use	8
Using your appliance	8
Useful information	9
Energy saving tips	9
Care and Maintenance	10-11
General	10
Defrosting	10
Power failure	10
Moving your appliance	11
Trouble Shooting	12
Technical Specifications	13
Disposal information	13
Guarantee	14

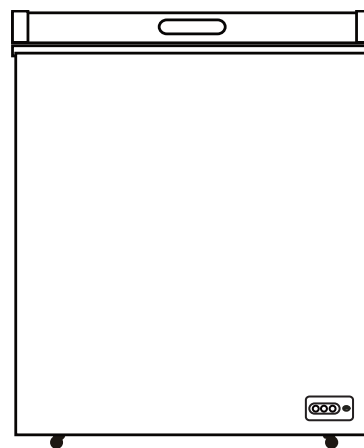

Product codes

BCF198L



Safety Information

Important – Please read these instructions fully before installation

Before use

The installation of this appliance is best carried out by 2 people.

- Dispose of all packaging carefully and responsibly.
- The appliance is designed for **indoor use only** and must be protected from rain, moisture and extreme temperature variations.
- This appliance is designed for household use. **Do not** use the appliance for industrial and commercial use, or any other purpose.
- The appliance **MUST** be positioned on a firm level base.
- **Do not** splash water on the appliance. It may cause electrical parts to fail and result in an electric shock.
- Leave the appliance in its intended place of installation and in its correct orientation for at least 4 hours before switching on to allow the cooling system to settle before first use or after any transportation.
- *Your appliance is an environmental friendly product and it contains non CFC / HFC gas substances in the cooling system (Called R600a) and in the insulation (Called cyclopentane) which are potentially flammable if exposed to fire. Therefore, take care not to damage, the cooling circuit / pipes of the appliance in transportation and in use. In case of damage do not expose the appliance to fire, potential ignition source and immediately ventilate the room where the appliance is situated.*
- **Do not** sit, stand or place any other heavy objects on top of the appliance. This could result in injury or damage to the appliance.
- **Do not** allow children to play with the appliance to avoid the risk of entrapment and suffocation.
- Keep ventilation opening, in the appliance enclosure or in the built-in structure, clear of obstruction.

During use

- This appliance is not intended for use by persons (including children) with reduced physical, sensory or mental capabilities, or lack of experience and knowledge, unless they have been given supervision or instruction concerning use of the appliance by a person responsible for their safety. Children should be supervised to ensure that they do not play with the appliance.
- This appliance is not intended for use by young children or infirm persons unless they have been adequately supervised by a responsible person to ensure that they can use the appliance safely. Young children should be supervised to ensure that they do not play with the appliance.
- **Do not** use mechanical, electrical or chemical way to speed up the defrost process not recommended by the manufacturer.
- **Do not** use or place other electrical products inside the appliance not recommended by the manufacturer.
- **Do not** store liquids in glass containers in the freezer compartment as these may shatter.
- **Do not** store flammable materials such as alcohol, gasoline, LP gas or glue etc in the appliance.
- In case there is an inflammable gas leaking, open the window for air circulation and do not pull out the plug or turn the temperature knob. **Do not** touch the appliance until the valve of gas is turned off. Otherwise, sparks may happen.
- **Do not** attempt to repair the appliance yourself. Contact the Customer Helpline: 0345 600 4632.



Safety Information

Important – Please read these instructions fully before installation

This appliance is intended to be used in household and similar applications such as

- staff kitchen areas in shops, offices and other working environments;
- farm houses and by clients in hotels, motels and other residential type environments;
- bed and breakfast type environments;
- catering and similar non-retail applications

This appliance can be used by children aged from 8 years and above and persons with reduced physical, sensory or mental capabilities or lack of experience and knowledge if they have been given supervision or instruction concerning use of the appliance in a safe way and understand the hazards involved. Children shall not play with the appliance. Cleaning and user maintenance shall not be made by children without supervision.

If the supply cord is damaged, it must be replaced by the manufacturer, its service agent or similarly qualified persons in order to avoid a hazard.

Do not store explosive substances such as aerosol cans with a flammable propellant in this appliance.

Refrigerant

The refrigerant isobutene (**R600a**) is contained within the refrigerant circuit of the appliance, a natural gas with a high level of environmental compatibility, which is nevertheless flammable. During transportation and installation of the appliance, ensure that none of the components of the refrigerant circuit becomes damaged.

The refrigerant (R600a) is flammable.



Caution: risk of fire

If the refrigerant circuit should be damaged:

- Avoid opening flames and sources of ignition.
- Thoroughly ventilate the room in which the appliance is situated.



Safety Information

Important – Please read these instructions fully before installation

- **WARNING** — Keep ventilation openings, in the appliance enclosure or in the built-in structure, clear of obstruction.
- **WARNING** — Do not use mechanical devices or other means to accelerate the defrosting process, other than those recommended by the manufacturer.
- **WARNING** — Do not damage the refrigerant circuit.
- **WARNING** — Do not use electrical appliances inside the food storage compartments of the appliance, unless they are of the type recommended by the manufacturer.
- **WARNING** — The refrigerant and insulation blowing gas are flammable. When disposing of the appliance, do so only at an authorized waste disposal centre. Do not expose to flame.

Part

If you have damaged or missing parts,
call the **Customer Helpline: 0345 600 4632**

Please familiarize yourself with the parts and accessories listed below

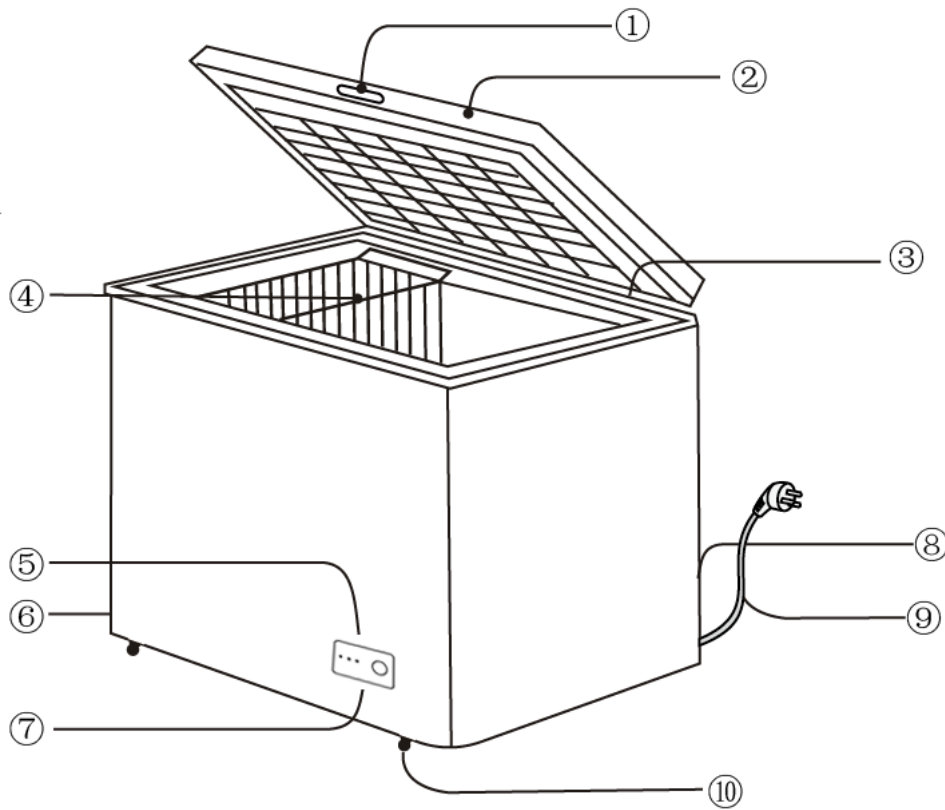

- 1. Door handle
- 2. Door
- 3. Hinge
- 4. Basket
- 5. Temperature knob

- 6. Drain cap
- 7. Power lamp
- 8. Side cover
- 9. Supply cord and plug
- 10. Foot/Castor

Accessories included

BUSH - Refrigeration



Instructions x 1

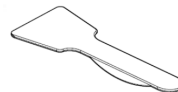

Scraper x 1

Installation

Transportation



Caution: 2 people are required to unpack and handle the appliance, it is recommended that gloves are worn.

- The appliance should be transported only in an upright position. Do not tilt the appliance greater than 45°. The packaging as supplied must be intact during transportation.
- After transporting the appliance, leave it for at least 4 hours before switching on to allow the cooling system to settle. Failure to comply could result in damage to the appliance.
- Do not move the appliance by pulling the door or handle as it may damage your flooring and wall coverings etc.
- Ensure the supply cable is not caught under the appliance during and after moving.
- Carefully remove all packaging materials including the foam base, dispose of correctly.

Installation

- Ensure sufficient spacing is provided for the appliance to be installed. Leave space on both sides (20cm), back (20cm) and above the appliance (70cm) to ensure proper ventilation.
- Do not place the appliance near a heat source or in direct sunlight.
- Do not put any heavy objects on top of the appliance. It will damage the appliance.
- Do not install the appliance in moist and wet place.
- It should be installed on a smooth surface to avoid excessive vibration and noise.
- Each appliance has a climate class (shown on the rating plate) where it indicates the temperature range of the appliance operation in place. The appliance may not work properly if it is left for a long period at a temperature outside the specified range.
- Refer to section “Care and Maintenance” to prepare your appliance for use.

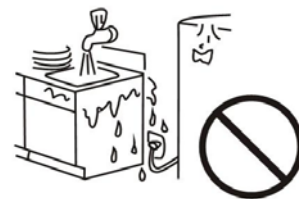
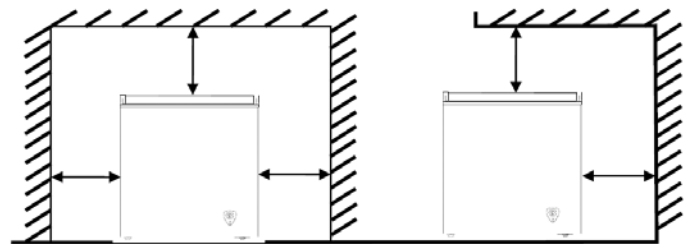

Climate Class	Amb. T. (°C)	Amb. T. (°F)
SN	10 ~ 32°C	50 ~ 90°F
N	16 ~ 32°C	61 ~ 90°F
ST	16 ~ 38°C	61 ~ 100°F
T	16 ~ 43°C	61 ~ 110°F

Installation

Electrical connection



Any electrical work that is required to install this appliance **MUST** be carried out by a qualified electrician.



Warning: THIS APPLIANCE MUST BE EARTHED

Before making any electrical connections, ensure that:

- Electrical safety is only guaranteed when the earth system of your house is in accordance with the related local regulations.
- Do not damage the refrigerant circuit.
- Do not bend, stretch or pull the supply cable to avoid electric shock.
- Do not use electrical appliances inside the food storage compartments of the appliance, unless they are of the type recommended by the manufacturer.
- Ensure the power socket is suitable for the maximum power of the machine (fuses in the power circuit must be 13 amp).
- The supply voltage should be the same as that indicated in the technical specifications and the appliance rating plate.
- The appliance should be earthed and in compliance with the applicable law.
- When installed, the power socket must be within easy reach.
- If the socket outlets in your home are not suitable for the plug supplied with this unit check with a qualified electrician for replacement.
- The use of adapters, multiple connectors or extension cables are not recommended.
- The appliance must be connected to a 220-240 volt 50Hz AC supply by means of a three pin socket, suitably earthed and protected by a 13 amp fuse.
- Should the fuse need to be replaced, a 13 amp fuse approved to BS1362/A must be used.
- The plug contains a removable fuse cover that must be refitted when the fuse is replaced. If the fuse cover is lost or damaged, the plug must not be used until a replacement cover has been fitted or the plug is replaced.
- A damaged plug should be cut off as close to the plug body as possible, the fuse should be removed and the plug disposed of safely.

Plug replacement (UK & Ireland only)

Should you need to replace the plug; the wires in the power cable are coloured in the following way:

Blue – Neutral 'N'

Brown – Live 'L'

Green & Yellow – Earth 'E'

As the colours of the wires in the power cable may not correspond with the coloured markings identifying the terminals in your plug, and proceed as follows:

The green & yellow wire must be connected to the terminal in the plug that is marked with the letter E or by the earth symbol.

The blue wire must be connected to the terminal that is marked with the letter N.

The brown wire must be connected to the terminal that is marked with the letter L.

If power supply cord is damaged, it must be replaced by the manufacturer or its service agent or a similar qualified person in order to avoid a hazard.

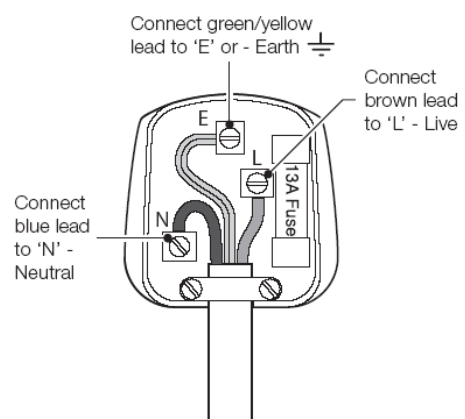

User Instructions

Before first use

Final checks before operating the appliance

1. Good air circulation around the appliance positioned.
2. The feet have been adjusted for perfect levelling.
3. Clean the compartment per recommendation in section "Care and Maintenance".
4. Plug in the appliance and power light will come on.





The compressor starts up and in operation may produce some background noise and it is normal, this is not a defect.

Using your appliance

1. Temperature adjustment

- The compartment temperature can be set by the temperature knob between "MIN" and "MAX" (coldest setting). We recommend setting the temperature knob midway first.
- To ensure the compartment is maintained at the desired temperature, it is advised to monitor the temperature periodically by a thermometer and adjust the temperature knob accordingly.
- Load the appliance after switch on for a while to allow the temperature reach the desired setting.

2. Storing frozen food

- The freezer compartment is  4 Star rated and suitable for the freezing and storage of pre frozen food.
- Check the food packaging for  suggestion before storage.

User Instructions

Useful information

The following guidelines and recommendations are suggested to obtain the best results and storage hygiene.

- Frequent door openings can cause internal temperature rise so the door shall be closed as soon as possible after use.
- For hygiene reasons, it is always a good practise to pack, wrap and cover the food before storing.
- Food shall cool to room temperature before storing.
- Do not fill the appliance with too much food: cold air must circulate freely for food to be preserved properly.
- Never re-freeze anything that has thawed out unless you cook it again, to kill off harmful bacteria.
- Never re-freeze thawed shellfish.
- Re-seal packs properly after removing items. This prevents drying or 'freezer burn' and a build up of frost on any remaining food.

Energy saving tips

- Place your freezer away from direct sunlight, your oven or any other heat sources. Allow 20 cm clear space on both sides and above, and at least 5 cm behind.
- Higher cold setting will use more energy. Do not set to maximum cold if it is not necessary.
- Frequently open and close door would cause internal temperature rise and it will consume more energy.
- Close the door(s) properly, and make sure the seals and hinges are airtight. Check the seals by putting a sheet of paper between the door and the main body of the fridge. If the paper moves, your seals need replacing.
- Defrost regularly. Accumulated ice layer should not be more than 5 mm thick.
- The pre-set position of basket has already set in the most efficient use of this product.

Care and Maintenance

General



Important: Always unplug the appliance from the power socket during cleaning and maintenance.

- Never use any sharp instruments or abrasive substances, soap, household cleaner, detergent or wax polish for cleaning.
- Use luke warm water to clean the cabinet of the appliance and wipe it dry.
- Never clean the appliance with flammable fluids. It could cause a damage and fire hazard.
- Clean the exterior of the appliance and door seal with a damp cloth and dry it through.
- Avoid water goes in the temperature control box. Clean with a dry cloth only.
- When the appliance is unplugged please wait for 5 minutes before plugging it in again. Otherwise, the compressor will be overloaded.
- Do not store bottled or canned drinks (especially carbonated drinks) in the freezer compartment. Bottles and cans may explode!
- Avoid prolonged touching of frozen food, ice or the inner freezer walls or tubing etc. Risk of frost burns to the skin.

Defrosting

- The appliance require defrosting once or twice a year when ice layer thickness reaches 5~10mm. Unplug the appliance from the mains before defrosting.
- Remove all frozen food from the freezer and roll it firmly in newspapers. Put it into a container in a cool place for temporary storage.
- Use an ice scraper (not provided) or similar tool to remove the ice layer. This process can be speed up by placing a pot of warm water inside the freezer.
- Open the drain hole cap to empty the defrosting water.
- Clean the freezer according to the steps above.
- Turn on the freezer and set to maximum temperature. Refill the frozen food to freezer.
- This process should be completed within 2 hours.

Power failure

In case there is a power failure, you should contact the electricity supply company and take the following actions:

If it is last within 24 hours, keep the doors closed. This will allow the stored food to stay cold as long as possible.

If it is last more than 24 hours, it is advised to empty the freezer compartment and temporarily store the food in a portable freezer or using artificial ice packs. Try to use up the food which is more easily perishable.

Remarks: Full appliance will stay cold longer than a partially filled one.

If ice crystals are still visible on the food, it may be frozen again, although flavour and aroma may be affected. If food is found to be in a poor condition, it is best to throw it away.

Short vacation

There is no need to disconnect the appliance from the mains if you will be away for two to three weeks. Use up the perishable food.

Care and Maintenance

Power failure

Long vacation

Remove all the food if you are away for three weeks or more. Unplug the appliance and leave the doors open to provide air circulation to prevent odour and mould.

Moving your appliance

Moving

Refer to section “Transportation” under “Installation”

Trouble Shooting

In the unlikely event of difficulties with your appliance please follow the trouble shooting guide below. If the problem persists, contact the retailer if the machine is still under guarantee. If the machine is out of guarantee, contact an approved service agent on **0345 600 4632**.

Problem	Possible cause	Solution
Appliance does not start	<ul style="list-style-type: none">• The mains plug is not plugged in.• Protection devices or fuses of the electrical system at home open	<ul style="list-style-type: none">• Insert the mains plug.• Check the protection devices and fuses.
Appliance not cool enough	<ul style="list-style-type: none">• Cooling system not settle after transportation• Doors not close properly• Frequently doors open• Loading food too much• Low temperature setting• Door seal dirty or sticky	<ul style="list-style-type: none">• Leave the appliance at least 4 hours before switching on• Check any food blockage• Reduce the frequency• Reduce the food quantity• Adjust the temperature knob• Clean per section "Care and Maintenance"
Noisy appliance	<ul style="list-style-type: none">• Not position on even surface• Appliance is touching objects around	<ul style="list-style-type: none">• Install on even surface and leveling the appliance• Ensure spacing at both sides and above the appliance

Technical Specifications

Model	BCF198L
Energy efficiency class	A+
Energy consumption – Kwh/year	219
Net storage – volume fresh food (litres)	0 L
Net storage – volume frozen food (litres)	198 L
Total net storage (litres)	198 L
Frozen food compartment rating	4 Star 
Climate class	SN/N/ST/T
Operating noise level dB(A)	42
Minimum Operating Temperature	10°C
Temperature rise value(min)	2700

We apologise for any inconvenience caused by any minor inconsistencies in these instructions, which may occur as a result of product improvements and development.



This appliance complies with the following EEC directives:
2006/95/EEC Low voltage directive
2004/108/EEC EMC directive

Disposal information



The symbol on the product or its packaging indicates that this product may not be treated as household waste. Instead it should be handed over to the applicable collection point for the recycling of electrical and electronic equipment. By ensuring this product is disposed of correctly, you will help prevent potential negative consequences for the environment and human health, which could otherwise be caused by inappropriate waste handling of this product. For more detailed information about recycling this product, please contact your local council office, your household waste disposal service or the shop where the product was purchased.

Remember: Old fridges must be disposed of carefully - older models contain CFC gases that are harmful - if in doubt, contact your local council for details on how to dispose of an old fridge.

Guarantee



PRODUCT GUARANTEE

This product is guaranteed against manufacturing defects for a period of



Year

This product is guaranteed for twelve months from the date of original purchase.

Any defect that arises due to faulty materials or workmanship will either be replaced, refunded or repaired free of charge where possible during this period by the dealer from whom you purchased the unit.

The guarantee is subject to the following provisions:

- The guarantee does not cover accidental damage, misuse, cabinet parts, knobs or consumable items.
- The product must be correctly installed and operated in accordance with the instructions contained in this manual.
- It must be used solely for domestic purpose.
- The guarantee will be rendered invalid if the product is re-sold or has been damaged by inexpert repair.
- Specifications are subject to change without notice.
- The manufacturer disclaims any liability for the incidental or consequential damages.
- The guarantee is in addition to, and does not diminish your statutory or legal rights.
- In the event of a problem with the product within the guarantee period call the Customer Helpline on 0345 600 4632.

Guarantor: Argos Ltd.
489 - 499 Avebury Boulevard
Central Milton Keynes
MK9 2NW